

# Voldue



## The most affordable yet efficient connected lighting solution for the creation of ambiance

The Voldue provides an affordable range of lighting solutions for creating ambiance. It combines a clean design and quality

lighting while significantly reducing energy and maintenance costs.

Designed to light pedestrian and low-speed areas with superior efficacy, Voldue optimises the return on investment.

This modern and compact LED luminaire is available with various control solutions including motion detection and remote management.

Voldue is the perfect tool for towns and cities looking for quality lighting with a minimum investment to ensure a fast payback.

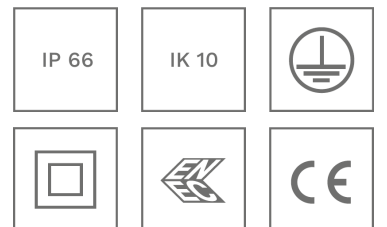

## Concept

The Voldue range combines the energy efficiency of LED technology with the photometric performance of the ProFlex™ concept developed by Schröder. The luminaire is composed of a two-piece housing made of painted die-cast aluminium. The protector in polycarbonate includes the lenses. Voldue is designed for post-top mounting on a 48-60mm diameter spigot.

The photometric versatility of the Voldue which provides both asymmetrical and symmetrical light distributions makes it the perfect tool for various lighting applications: pedestrian areas (parks, squares...), bike paths, residential streets and urban roads.

Voldue proposes a broad range of control options: programmable drivers, photocell, remote management and motion detection features with a PIR sensor. The luminaires can be equipped with a Nema 7-pin socket and the LUCO-P7 or LUCO-P7 CM compatible with the Owlet IoT City Management System.



The direct integration of the lenses in the polycarbonate protector optimises the flux.



Louvres can be fitted around the optics to enhance visual comfort.

## Types of application

- URBAN & RESIDENTIAL STREETS
- BRIDGES
- BIKE & PEDESTRIAN PATHS
- RAILWAY STATIONS & METROS
- CAR PARKS
- SQUARES & PEDESTRIAN AREAS

## Key advantages

- Cost-effective and efficient lighting solution for a fast return on investment
- ThermiX® to withstand high temperatures
- Post-top mounting adapted to Ø48-60mm spigots
- ProFlex™ photometric engines providing asymmetrical and symmetrical lighting distributions
- Supplied pre-cabled to facilitate its installation
- Designed to incorporate the Owlet range of control solutions



The 7-pin NEMA socket can be equipped with a shorting cap at delivery.



The luminaire is mounted on a Ø48-60mm spigot by tightening two M8 screws.



ProFlex™

The ProFlex™ photometric engine integrates the lenses into a polycarbonate protector. This integration increases the output and reduces the reflection inside the optical unit. The polycarbonate used for the ProFlex™ photometric engine offers essential characteristics such as high optical clarity for a superior light transmission, better impact resistance compared to glass and a long life span with UV-stabilisation treatment. The ProFlex™ concept enables a compact design with a thin optical compartment. It provides extensive light distributions so that the spacing between the luminaires can be increased.





### Constant Light Output (CLO)

This system compensates for the depreciation of luminous flux to avoid excess lighting at the beginning of the installation's service life. Luminous depreciation over time must be taken into account to ensure a predefined lighting level during the luminaire's useful life. Without a CLO feature, this simply means increasing the initial power upon installation in order to make up for luminous depreciation. By precisely controlling the luminous flux, the energy needed to reach the required level can be maintained throughout the luminaire's life.

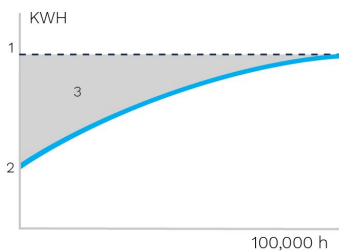

1. Standard lighting level | 2. LED lighting consumption with CLO | 3. Energy savings



### Custom dimming profile

Intelligent luminaire drivers can be programmed with complex dimming profiles. Up to five combinations of time intervals and light levels are possible. This feature does not require any extra wiring. The period between switching on and switching off is used to activate the preset dimming profile. The customised dimming system generates maximum energy savings while respecting the required lighting levels and uniformity throughout the night.

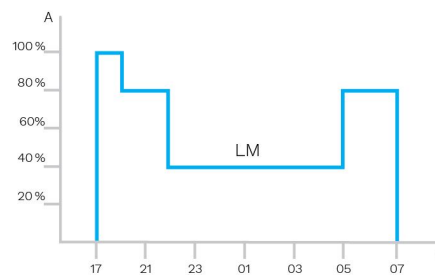

A. Performance | B. Time



### Daylight sensor / photocell

Photocell or daylight sensors switch the luminaire on as soon natural light falls to a certain level. It can be programmed to switch on during a storm, on a cloudy day (in critical areas) or only at night fall so as to provide safety and comfort in public spaces.

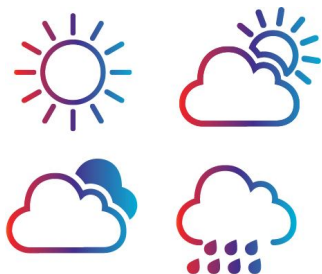

### PIR sensor: motion detection

In places with little nocturnal activity, lighting can be dimmed to a minimum most of the time. By using passive infrared (PIR) sensors, the level of light can be raised as soon as a pedestrian or a slow vehicle is detected in the area. Each luminaire level can be configured individually with several parameters such as minimum and maximum light output, delay period and ON/OFF duration time. PIR sensors can be used in an autonomous or interoperable network.



## Owlet IoT

Owlet IoT remotely controls luminaires in a lighting network, creating opportunities for improved efficiency, accurate real-time data and energy savings of up to 85%.



### ALL-IN-ONE

The LUCO P7 CM controller includes the most advanced features for optimised asset management. It also provides an integrated photocell and operates with an astronomical clock for seasonal dimming profile adaptations.

### EASY TO DEPLOY

Thanks to wireless communication, no cabling is needed. The network is not subject to physical constraints or limitations. From a single control unit to an unlimited network, you can expand your lighting scheme at any time. With real-time geolocation and automatic detection of luminaire features, commissioning is quick and easy.

### USER-FRIENDLY

Once a controller is installed on a luminaire, the luminaire automatically appears with its GPS coordinates on a web-based map.

An easy-to-use dashboard enables each user to organise and customise screens, statistics and reports. Users can gain relevant, real-time insights.

The Owlet IoT web application can be accessed at all times from anywhere in the world with a device connected to the Internet. The application adapts to the device to offer an intuitive and user-friendly experience.

Real-time notifications can be pre-programmed to monitor the most important elements of the lighting scheme.



Plugging the LUCO P7 CM controller onto the 7-pin NEMA socket

### SECURE

The Owlet IoT system uses a local wireless mesh communication networks to control the on-site luminaires combined with a remote control system utilising the cloud to ensure smooth data transfers to and from the central management system.

The system uses encrypted IP V6 communication to protect data transmission in both directions. Using a secure APN, Owlet IoT ensures a high level of protection.

In the exceptional case of a communication failure, the built-in astronomical clock and photocell will take over to switch the luminaires on and off, thus avoiding a complete blackout at night.

### EFFICIENT

Thanks to sensors and/or pre-programmed settings, lighting scenarios can be easily adapted to cope with live events, providing the right lighting levels at the right time and in the right place.

The integrated utility grade meter offers the highest accuracy available on the market today, enabling decisions based on real figures.

Accurate real-time feedback and clear reporting ensures that the network operates efficiently and maintenance is optimised.

When LED luminaires are switched on, the inrush current can create problems for the electricity grid. Owlet IoT incorporates an algorithm to preserve the grid at all times.

### OPEN

The LUCO P7 CM controller can be plugged onto the standard 7 pin NEMA socket and operates through either a DALI or 1-10V interface to control the luminaire.

Owlet IoT is based on the IPv6 protocol. This method for addressing devices can generate an almost unlimited number of unique combinations to connect non-traditional components to the Internet or computer network.

Through open APIs, Owlet IoT can be integrated into existing or future global management systems.

## GENERAL INFORMATION

Recommended installation height	3m to 5m   10' to 16'
Driver included	Yes
CE Mark	Yes
ENEC certified	Yes
ROHS compliant	No
Testing standard	LM 79-08 (all measurements in ISO17025 accredited laboratory)

## HOUSING AND FINISH

Housing	Aluminium
Optic	Polycarbonate
Protector	Polycarbonate (with integrated lenses)
Housing finish	Polyester powder coating
Standard colour(s)	AKZO grey 900 sanded
Tightness level	IP 66
Impact resistance	IK 10
Vibration test	Compliant with modified IEC 68-2-6 (0.5G)
Access for maintenance	By loosening screws on the bottom cover

· Any other RAL or AKZO colour upon request

## OPERATING CONDITIONS

Operating temperature range (Ta)	-30 °C up to +45 °C / -22 °F up to 113 °F
----------------------------------	---

· Depending on the luminaire configuration. For more details, please contact us.

## ELECTRICAL INFORMATION

Electrical class	Class I EU, Class II EU
Nominal voltage	220-240V – 50-60Hz
Power factor (at full load)	0.9
Surge protection options (kV)	4 10
Electromagnetic compatibility (EMC)	EN 61547 / EN 61000-4-2, -3, -4, -5, -6, -8, -11
Control protocol(s)	1-10V, DALI
Control options	Bi-power, Custom dimming profile, Remote management
Socket option(s)	NEMA 7-pin (optional)
Associated control system(s)	Owlet IoT
Sensor	PIR (optional)

## OPTICAL INFORMATION

LED colour temperature	3000K (Warm White) 4000K (Neutral White)
Colour rendering index (CRI)	>70 (Warm White) >80 (Warm White) >70 (Neutral White)
Upward Light Output Ratio (ULOR)	0%

· ULOR may be different according to the configuration. Please consult us.

## LIFETIME OF THE LEDS @ TQ 25°C



All configurations	100,000h - L80
--------------------	----------------

## DIMENSIONS AND MOUNTING

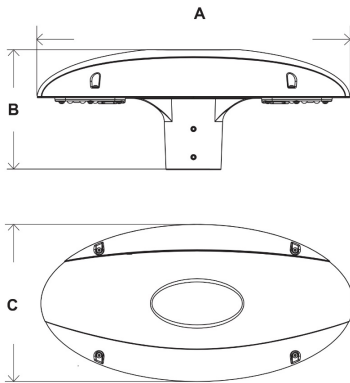
AxBxC (mm   inch)	501x192x251   19.7x7.6x9.9
Weight (kg   lbs)	4   8.8
Aerodynamic resistance (CxS)	0.08
Mounting possibilities	Post-top slip-over – Ø48mm Post-top slip-over – Ø60mm





Luminaire	Number of LEDs	Current (mA)	Luminaire output flux (lm) Neutral White 740		Luminaire output flux (lm) Warm White 830		Power consumption (W)	Luminaire efficacy (lm/W)	Photometry
			Min	Max	Min	Max			
VOLDUE	12	500	2000	2200	1900	2000	20.3	108	
	12	700	2700	3000	2500	2700	28.9	104	
	12	1000	3600	3900	3300	3600	42.5	92	

Tolerance on LED flux is  $\pm 7\%$  and on total luminaire power  $\pm 5\%$



